



KEY FEATURES

- Professional LED floodlight to use up to 14 meters
- Special asymmetric lens with 0% LOR
- Integrated LED driver
- Uniform light distribution
- Included 3-pole IP68 connector
- Included 1.5 meter cable
- IK08 Vandal-proof / Impact-resistant Aluminum housing and glass cover
- Angle mounting (45°) and tilting up to 180°
- Long service life of 100,000 hour (L80B10) 50,000 (L90B50)
- Suitable for use temperatures: -30 to + 50 ° C
- Installation on wall and/or pole (accessories needed-not included)
- 5 year Pragmalux Warranty

IP66 IK08 650°GWT 133LM/W 55x110°

5 PRAGMALUX
YEAR
WARRANTY

7 PRAGMALUX
YEAR
WARRANTY
EXTENDED-PRO

DETAILS



Back



Pole adaptor

OPTIONS

3000K 5000K

ACCESSORIES



Protection Mesh
50W - 4605463



Protection Mesh
100W - 4605470



Protection Mesh
150W - 4605487



Protection Mesh
200W - 4605494



Protection Mesh
300W - 4605500



Pole adaptor Ø42
4605432



Pole adaptor Ø60
4605449



Pole adaptor Ø72
4605456



2 Flood Base
10000268

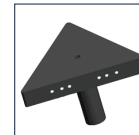

3 Flood Base
10000251

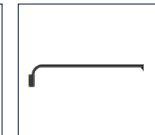

Arm 1 meter
10000275

SPECIFICATIONS

ITEM CODE	DESCRIPTION	W	LM	LM/W	KELVIN	CRI	INPUT CURRENT	LIFETIME L80B10	EQUIVALENT	BEAM ANGLE
4605388	LED Floodlight Auva IP66 50W 4000K Asymmetrical	50	6600	132	4000	≥80	0.25	100000	100W	55x110°
4605395	LED Floodlight Auva IP66 100W 4000K Asymmetrical	100	12900	129	4000	≥80	0.5	100000	150W	55x110°
4605401	LED Floodlight Auva IP66 150W 4000K Asymmetrical	150	19900	133	4000	≥80	0.73	100000	250W	55x110°
4605418	LED Floodlight Auva IP66 200W 4000K Asymmetrical	200	26400	132	4000	≥80	0.98	100000	400W	55x110°
4605425	LED Floodlight Auva IP66 300W 4000K Asymmetrical	300	40000	133	4000	≥80	1.45	100000	800W	55x110°

TECHNICAL DATA

ELECTRICAL DATA	
Voltage (V)	220-240
Frequency (Hz)	50/60
Power factor (λ)	≥0.9
Operating mode	Integrated LED Driver
Electrical connection	Max 3x105 mm ² wire
Total harmonic distortion	≤ 20 %

TEMPERATURES & OPERATING CONDITIONS	
Ambient temperature	25°C
Operating temperature	-30 ~ +50°C
Storage temperature	-40 ~ +85°C

COLORS & MATERIALS	
Color (Housing)	Black RAL9017
Material (Housing)	Aluminum
Material (Reflector)	Tempered glass

CERTIFICATES & STANDARDS	
Driver certificates	CE
Fixture certificates	CE / ENEC
Ingress protection	IP66
Protection class	I
Protection class IK	08
Glow Wire Test (IEC 695-2-1)	650°C
Photobiological safety group EN62778	RG1
IEC	EN IEC 62722-2-1
LM80 (TM21) L90B50 (hours)	>50,000

CAPABILITIES	
UGR	≤25-30
Dimmable	No / 1-10V Dimming
Type of connection	Push Terminal, 3-pole
LED Module replacable	No
Installation	Wall-Surface mounted / Pole mounted

PRAGMALUX

All rights reserved. Pragmalux - PDL Lighting Group B.V. retains the right to modify product specifications without any prior notice or obligation and does not assume any liability for any consequences of using this document. Subject to errors and printing errors. Luminous flux tolerance: +/- 10%. Power consumption tolerance: +/- 10%.

Version: June 2021

ITEM CODE	DESCRIPTION	DRIVER FAILURE RATE AT 5,000H	INRUSH CURRENT IPEAK (A)	INRUSH CURRENT TWIDTH (µs)	MAX. NO. OF DRIVERS ON MCB TYPE B 10A	MAX. NO. OF DRIVERS ON MCB TYPE B 16A	MAX. NO. OF DRIVERS ON MCB TYPE C 10A	MAX. NO. OF DRIVERS ON MCB TYPE C 16A
4605388	LED Floodlight Auva IP66 50W 4000K Asymmetrical	≤1%	60	450	5	9	10	16
4605395	LED Floodlight Auva IP66 100W 4000K Asymmetrical	≤1%	60	450	2	4	4	8
4605401	LED Floodlight Auva IP66 150W 4000K Asymmetrical	≤1%	60	650	2	4	4	7
4605418	LED Floodlight Auva IP66 200W 4000K Asymmetrical	≤1%	60	650	2	4	4	7
4605425	LED Floodlight Auva IP66 300W 4000K Asymmetrical	≤1%	80	650	1	2	2	2

DIMENSIONS

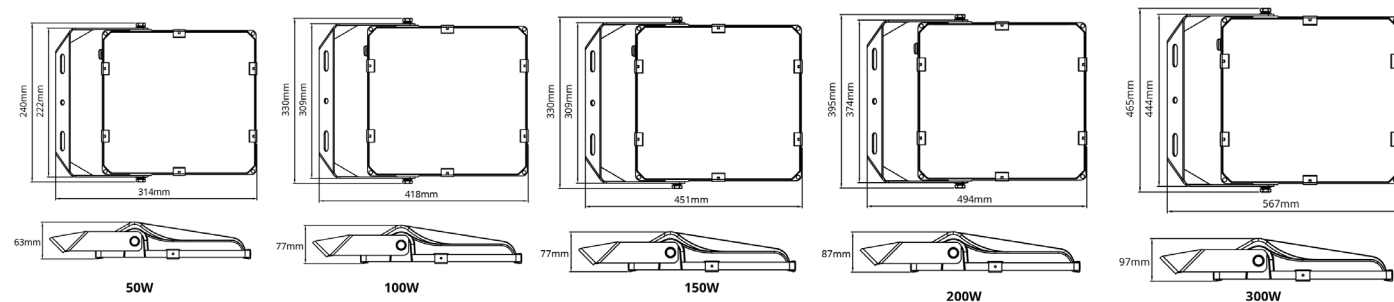

PHOTOMETRIC SPECIFICATIONS

LED FLOODLIGHT AUVA 50W 4000K

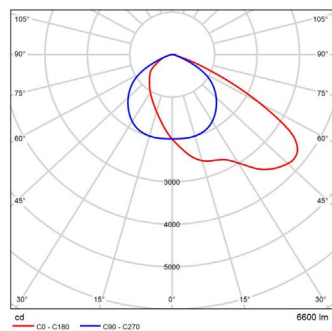

LED FLOODLIGHT AUVA 100W 4000K

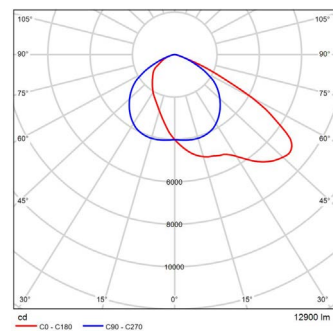

LED FLOODLIGHT AUVA 150W 4000K

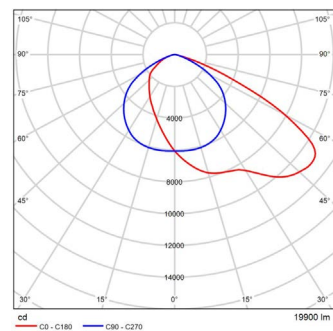

LED FLOODLIGHT AUVA 200W 4000K

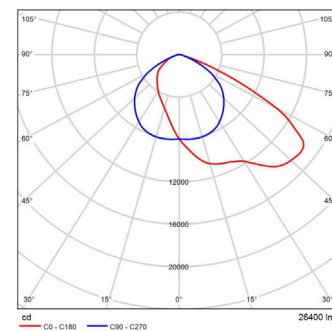

LED FLOODLIGHT AUVA 300W 4000K

